

REPAIR PARTS FOR 175 LB. DROP SPREADER MODEL 45-02882

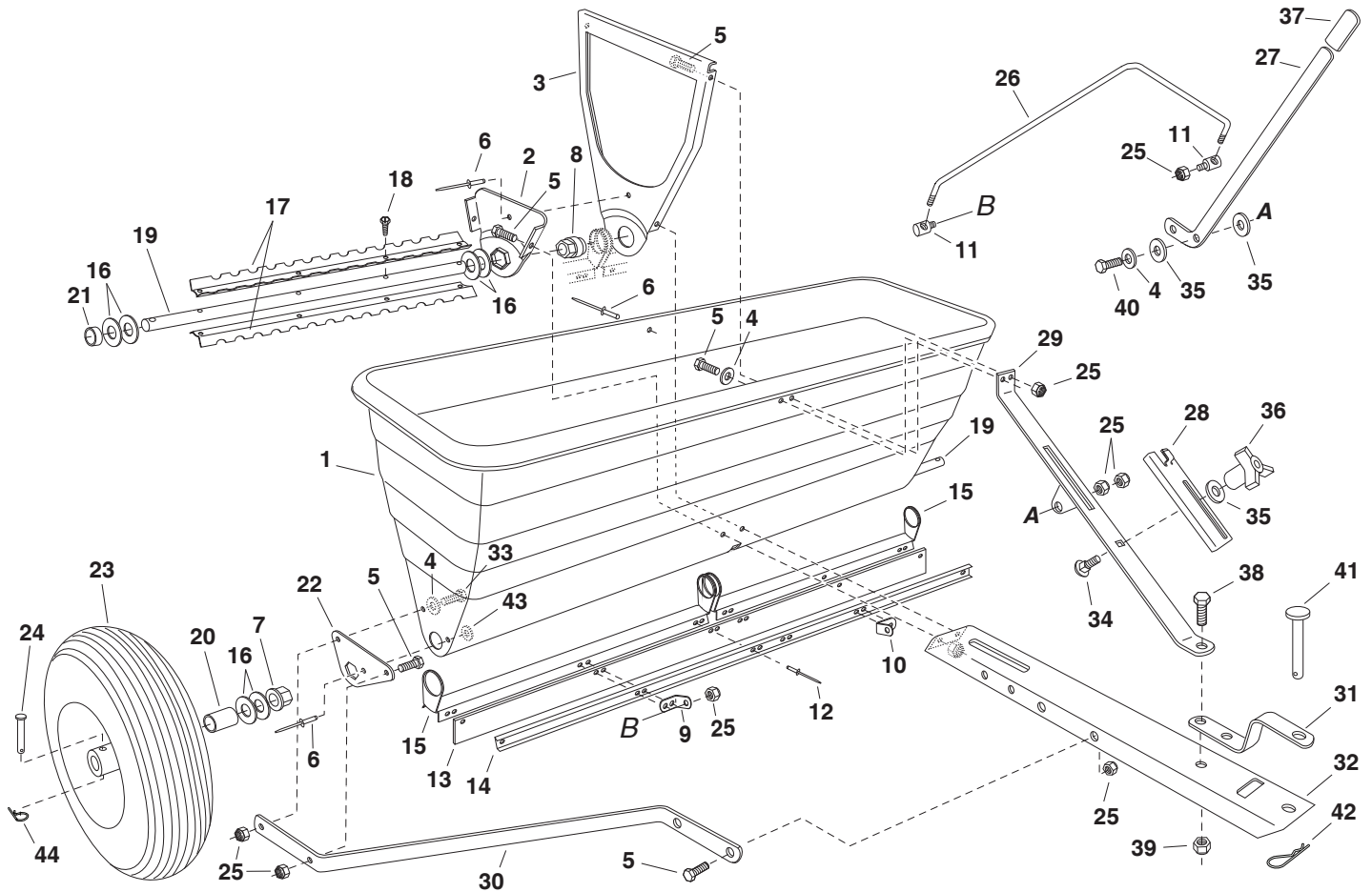

REF. NO.	PART NO.	QTY.	DESCRIPTION	REF. NO.	PART NO.	QTY.	DESCRIPTION
1	47451	1	Hopper	24	46867	2	Clevis Pin, 1/4" x 1-3/4"
2	24536	1	Hopper Center Plate (Small)	25	47189	16	Nylock Nut, 1/4-20 Thd.
3	24535	1	Hopper Center Plate (Large)	26	47712	1	Rod, Flow Control
4	43088	4	Washer, 1/4"	27	24660	1	Arm, Flow Control
5	43866	10	Bolt, Hex 1/4-20 x 5/8"	28	24542	1	Gauge, Flow Control
6	48373	6	Pop Rivet	29	63850	1	Brace Assembly, Hopper
7	47615	2	Bearing, Flange	30	24532	2	Brace, Tongue
8	47484	1	Bearing, Hex Flange	31	23014	1	Hitch Bracket
9	24538	1	Bracket, Feed Plate (RH)	32	24531	1	Tongue
10	24539	1	Bracket, Feed Plate (LH)	33	43012	2	Bolt, Hex 1/4-20 x 3/4"
11	47711	2	Ferrule	34	44950	1	Bolt, Carriage 1/4-20 x 3/4" Lg.
12	728-3001	10	Pop Rivet	35	1543-69	3	Washer, Nylon
13	47459	1	Skirt, 48"	36	43849	1	Knob, Plastic 1/4-20 Thd.
14	47508	1	Retainer, Skirt	37	43848	1	Grip, Plastic
15	24537	2	Flow Plate	38	43001	1	Bolt, Hex 3/8-16 x 1" Lg.
16	43009	10	Washer	39	HA21362	1	Nut, Hex Lock 3/8-16 Thd.
17	47259	4	Agitator Blade	40	1509-90	1	Bolt, Hex 1/4-20 x 1-1/4" Lg.
18	47978	16	Screw, #8-32 x 1/4" Lg.	41	47623	1	Hitch Pin, 3/8"
19	24540	2	Axle	42	43343	1	Hair Cotter Pin, 1/8"
20	48665	2	Spacer, Tube 1" OD x 1.65" Lg.	43	736-0142	2	Washer 1/4" x 5/8"
21	47458	2	Spacer, 1.25" OD x .330" Lg.	44	43055	2	Hair Cotter Pin, 3/32"
22	24534	2	Plate, Bearing		40944	1	Owners Manual
23	40939	2	Wheel				