



# WALKER

## A16: Boom Sprayer

# Operator's Manual

Safety, Assembly, Operating, and Maintenance Instructions

Compatible on decks: 42", 48", 52", 60", and 62"



**Please Read and Save These Instructions**

For Safety, Read All Assembly and Operation Instructions  
Prior to Operating Attachment

Release Date: 12.15.20

P/N: 7662-14



## Foreword

Thank you. . . for purchasing a Walker Boom Sprayer. Every effort has been made to provide you with the most reliable equipment on the market, and we are sure you will be among our many satisfied customers. If for any reason this product does not perform to your expectations, please contact your local dealer. Every customer is important to us. Your satisfaction is our goal.

**Please.** . . read this manual thoroughly! Before you operate your sprayer, please read this entire manual. Some of the information is crucial for proper operation and maintenance of the sprayer—it will help protect your investment and ensure that the equipment performs to your satisfaction. Some of the information is important for your safety and must be read and understood to help prevent possible injury to the operator and others. If anything in this manual is confusing or hard to understand, please contact your local authorized dealer or call our service department, at (970) 221-5614, for clarification before operating or servicing this machine.

This manual covers the A16 Boom Sprayer and the individual mounting kits for the supported decks.

**All shields and guards must be in place for the proper and safe operation of this equipment.** Where they are shown removed in this manual, it is for illustration purposes only. **Do not operate this equipment unless all shields and guards are in place.**

Walker Mfg. Co. is continually striving to improve the design and performance of its products. We reserve the right to make changes in specifications and design without thereby incurring any obligation relative to previously manufactured products.

Sincerely,  
WALKER MANUFACTURING COMPANY

A handwritten signature in black ink that reads "Bob Walker". The signature is written in a cursive, flowing style.

Bob Walker, Chairman

# Table of Contents

## **General Information** **1**

Highlighted Information .....	1
Glossary .....	1
Unit Description.....	1
Model and Serial Number .....	1

## **Specifications** **2**

Deck Compatibility .....	2
--------------------------	---

## **Component Identification** **3**

## **Safety Instructions** **4**

Before Operating.....	4
Operating .....	5
Maintenance .....	6
Safety, Control, and Instruction Decals.....	7

## **Assembly and Installation** **8**

Assembly .....	8
Installation.....	10

## **Operating** **11**

Chemical Safety.....	11
Pump Operating Pressures.....	11
Calibrating the Application Rate.....	11
Operating the Sprayer.....	12
Installing the Wind Screen .....	12
Cleaning the Sprayer .....	12

## **Maintenance** **13**

Cleaning the Strainers .....	13
<i>Spray Boom Tip Strainers</i> .....	13
<i>Sump Strainer</i> .....	13
<i>Spray Wand Tip</i> .....	13
Storage of the Sprayer.....	13

## **Troubleshooting** **14**

Pump Loses Suction .....	14
Pump Capacity Decreased .....	14
Poor Spray Pattern .....	14
Pump Vibrates or Switches On and Off .....	14
Pump Does Not Run .....	14

## **Parts Lists and Diagrams** **15**

A16 Boom Sprayer Parts List.....	15
A16 Boom Sprayer Parts Diagram.....	16

## General Information

### HIGHLIGHTED INFORMATION

Walker Manufacturing recommends that any service requiring special training or tools be performed by an authorized Walker Mower dealer. There are several general practices to be aware of in the area of safety. Most accidents associated with the operation or maintenance of a Walker Mower are caused by disregarding basic safety precautions or specific warnings. Such accidents, in most cases, can be prevented by being aware of the dangers present.

Information of special importance has been highlighted in bold type in this manual. Refer to **Safety Instructions on page 4** for the meanings of **DANGER, WARNING, CAUTION, IMPORTANT,** and **NOTE.**

### GLOSSARY

There are many terms that are either unique to this equipment or that are used as acronyms. The following terms and their definitions will help while using this manual:

- **LEFT HAND (LH)** refers to the left-hand side of the tractor when the operator is seated facing forward in the tractor seat.
- **RIGHT HAND (RH)** refers to the right-hand side of the tractor when the operator is seated facing forward in the tractor seat.
- **TRACTOR** is the prime mover, including the engine, drivetrain, operator seat, and controls to operate the mower.
- **SPRAYER BOOM** is the spray nozzle support consisting of a central main piece and two (2) folding extensions mounted on the front of the sprayer.
- **SPRAY WAND** is the handheld sprayer.

## UNIT DESCRIPTION

The A16 Boom Sprayer utilizes a 25 gallon tank and operates at 100 PSI. The unit has an actual spraying time of about 42 minutes when using the spray wand, or 20 minutes when using the boom sprayer. The spray wand or the boom sprayer can be selected using an electric switch located on the unit, and accessible from the operator seat. A windscreen is also included with the unit for use in windy conditions.

## MODEL AND SERIAL NUMBER

The boom sprayer serial number is affixed to the top of the tank in between the pump and the cap. Model and serial numbers are helpful when obtaining replacement parts and maintenance assistance. For ready reference, please record these numbers in the space provided.

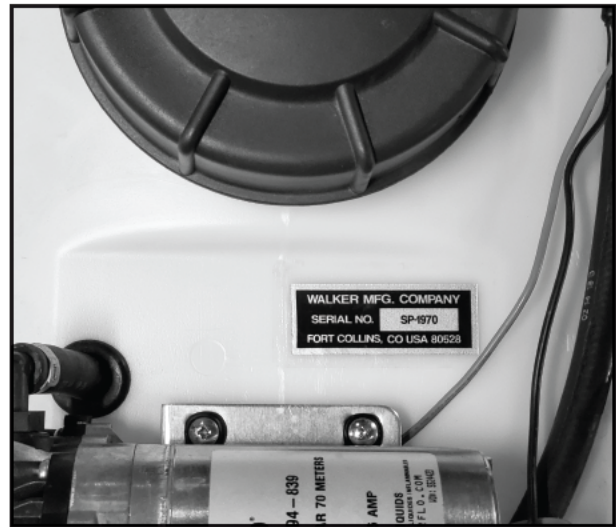

Location of Serial Number

Boom Sprayer Model No. _____
Boom Sprayer Serial No. _____
Date of Purchase _____

## Specifications

BOOM SPRAYER	A16
Tank Capacity Gal (L)	25 (94.6)
Width Tank Only in. (cm)	33 (83.8)
Width w/ Arms Extended in. (cm)	61-1/4 (155.6)
Height in. (cm)	24-1/2 (62.2)
Length in. (cm)	27 (68.6)
Spray Tip Size	11008 EVS
Effective Spray Width in. (cm)	96 (243.8)
Sprayer Weight (Empty) lbs (kg)	50 (22.7)
Pump Type	12V Electric Diaphragm
Current Draw	7 Amps
Fuse Size	15 Amp
System Pressure	100 PSI

**NOTE:** The manufacturer reserves the right to make changes in specifications shown herein at any time without notice or obligation.

### DECK COMPATIBILITY

The A16 Boom Sprayer is supported on the following decks. As new decks are added, this list may not be complete, so check with your Walker Dealer if you have any questions.

- DC42
- DC42R
- DC48
- DC48R
- DC52R
- DS42
- DS48
- DS52\*
- DS60\*
- DS62\*
- DM42
- DM42A/B
- DM48
- DM52A

\* The A16 ships with support brackets to mount on most compatible decks. Differences in the carrier frames require additional hardware for the A16 to be installed on these decks.

**For the DS52 and DS62:** Order two (2x) *B037 Mounting Bracket, 52/62*.

**For the DS60:** Order two (2x) *B028-1 Support Bracket/60, Rear*, **and** one (1x) *B005-1 30" Wire Harness Ext.*

## Component Identification

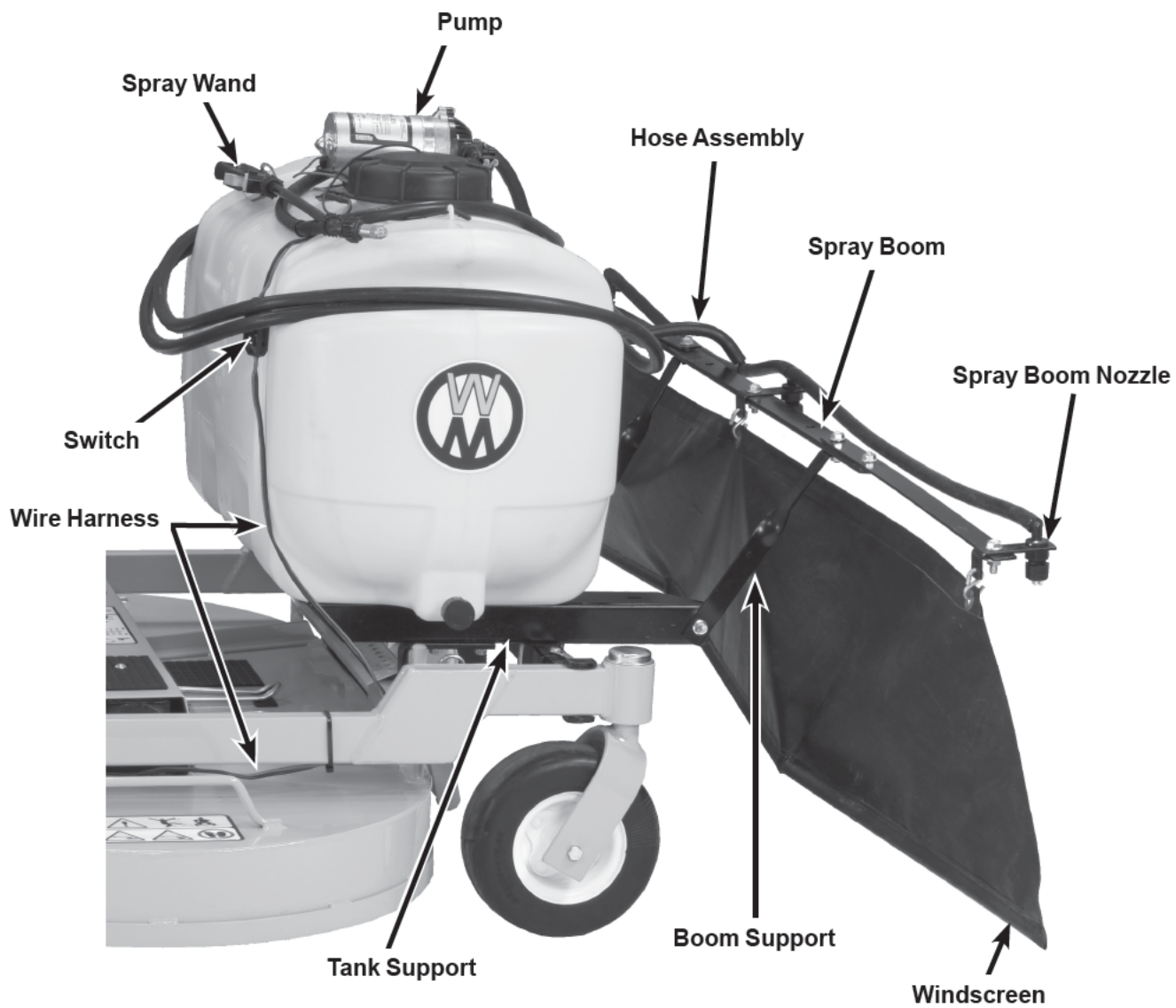

A16 Boom Sprayer with Windscreen

# Safety Instructions

Pay particular attention to any information labeled **DANGER, WARNING, CAUTION, IMPORTANT,** and **NOTE** in this manual.

When you see the Safety Alert Symbol (  ), read, understand, and follow the instructions. Failure to comply with safety instructions may result in personal injury.

The seriousness or degree of importance of each type of information is defined as follows:

 <b>DANGER</b>
An <b>IMMEDIATE</b> hazard that <b>WILL</b> result in severe personal injury or <b>DEATH</b> , if warning is ignored and proper safety precautions are not taken.

 <b>WARNING</b>
A <b>POTENTIAL</b> hazard that <b>COULD</b> result in severe personal injury or <b>DEATH</b> , if warning is ignored and proper safety precautions are not taken.

 <b>CAUTION</b>
Possible hazards or unsafe practices that <b>MAY</b> result in <b>MODERATE</b> personal injury or property damage, or machine damage, if warning is ignored and proper safety precautions are not taken.

**IMPORTANT:** Identifies mechanical information demanding special attention, since it deals with the possibility of damaging a part or parts of the machine.

**NOTE:** Identifies information worthy of special attention.

Walker Manufacturing cannot predict every potentially dangerous situation. Therefore, items labeled as such in this manual do not cover all conceivable situations. Any person using procedures, tools, or control techniques not recommended by Walker Manufacturing must take full responsibility for safety.

The Walker Rider Lawnmower has been designed with many safety features to protect the operator from personal harm or injury. However, it is necessary for the operator to use safe operating procedures at all times. **Failure to follow safety instructions contained in this manual may result in personal injury or damage to equipment or property.**

If you have any questions concerning setup, operation, maintenance, or safety, please contact your authorized Walker Mower dealer or call Walker Manufacturing Company at (970) 221-5614.

## BEFORE OPERATING

1. **Read and understand the contents of this Operator's Manual before starting and operating the machine.** Become thoroughly familiar with all machine controls and how to stop the machine and disengage the controls quickly. Replacement Operator's Manuals are available by sending the Model and Serial Number to:  
  

**Walker Manufacturing Company**  
 5925 East Harmony Road  
 Fort Collins, CO 80528
2. **Never allow children to operate a rider mower.** Do not allow adults to operate without proper instruction.
3. Keep everyone, especially children and pets, a safe distance away from the area being sprayed. **Do not spray with bystanders in the area.**
4. Do not wear loose fitting clothing that could get caught in moving parts.
5. **Always wear adequate protective clothing** including long pants, substantial protective footwear, gloves, and eye protection when spraying. Wear a mask or face shield if necessary.
6. Always wear appropriate safety gear when handling and mixing the chemicals used in the sprayer.

7. Always check all hoses and nozzles on the sprayer for leaks before any start up.
8. Prolonged exposure to loud noise can cause impairment or loss of hearing. **Operator hearing protection is recommended.** Wear a suitable hearing protective device, such as earmuffs or earplugs.
9. **Keep all protective shields and safety devices in place.** If a protective shield, safety device, or decal is damaged, unusable, or missing, repair or replace it **before** operating the machine.
10. **Be sure interlock switches are functioning correctly,** so the engine cannot be started unless the Forward Speed Control lever is in the **NEUTRAL-PARK** position, the PTO clutch is in the **DISENGAGED** position, and the Parking Brake is in the **ENGAGED** position. Also, the engine should stop if the operator lifts off the seat with any one or more of these controls in the operating position: (1) Forward Speed Control (FSC) out of **NEUTRAL-PARK**, (2) PTO Clutch **ENGAGED**, or (3) Parking Brake **DIS-ENGAGED**.
11. **Handle gasoline with care.** Gasoline is highly flammable and its vapors are explosive:
  - a. Use an approved fuel container.
  - b. Never add fuel to a running engine or hot engine (allow hot engine to cool several minutes).
  - c. Keep matches, cigarettes, cigars, pipes, open flames, or sparks away from the fuel tank and fuel container.
  - d. Always fill the fuel tank outdoors using care. Fill to about one inch from the top of the tank. Use a funnel or spout to prevent spilling.
  - e. Replace the machine fuel cap and container cap securely and clean up any spilled fuel before starting the engine.
12. **Never attempt to make any adjustments while the engine is running,** except where specifically instructed to do so.

13. The electrical system battery contains sulfuric acid. Avoid any contact with skin, eyes, and clothing. Keep the battery and acid out of reach of children.

 **WARNING**

This product can expose you to chemicals including Di-(2-ethylhexyl) phthalate which is known to the State of California to cause cancer, and Di-(2-ethylhexyl) phthalate, which is known to the State of California to cause birth defects or other reproductive harm. For more information go to [www.P65Warnings.ca.gov](http://www.P65Warnings.ca.gov).

### OPERATING

**NOTE:** Refer to your tractor Operator's Manual for safety instructions for operating the tractor.

1. **Operate the machine only in daylight** or in good artificial light with good visibility of areas being cleaned.
2. Sit on the seat when starting the engine and operating the machine. Keep feet on footrests at all times when the tractor is moving and/or the implement is operating.
3. For a beginning operator, **learn to steer (maneuver) the tractor with a slow engine speed before attempting any implement operation.** Be aware that, with the front mounted implement configuration, the back of the machine swings to the outside during turns.

 **DANGER**

**Do not operate around overhanging tree branches or bushes at the same height as the operator's torso and head where inadvertent contact may cause injury.**

4. Remember, for an emergency stop, the forward motion of the tractor can always be stopped by pulling the Forward Speed Control (FSC) into the **NEUTRAL-PARK** position.
5. In case the transmission drive belt breaks during operation, and if the machine is on a slope, the machine will freewheel down the slope. **To maintain control,** immediately (1)



Release the steering levers and simultaneously (2) Move the FSC to the **NEUTRAL-PARK** position. When the machine is stopped or moving slowly, engage the parking brake.

**NOTE:** The emergency stop procedure is exactly the same procedure used to normally stop and park the machine.

6. Disengage the PTO clutch and put the FSC in the **NEUTRAL-PARK** position before starting the engine (an ignition interlock switch normally prevents starting of the tractor if these controls are in the **OPERATING** position).
7. **Do not operate machine if the operator presence safety switch system is not working.** Verify proper operation by having the operator lift off the seat with the engine running and moving three controls, one at a time; (1) Move the FSC lever out of the **NETRAL-PARK** position, (2) Engage the PTO Clutch, and (3) Disengage the Parking Brake. Moving any of these controls should stop the engine after a 1/2 second delay.
8. **Do not run the engine in a confined area without adequate ventilation.** Exhaust fumes are hazardous and can be deadly.
9. **Do not carry passengers** - maximum seating capacity is one (1) person.
10. **Avoid sudden starts or stops.** Before backing the machine up, look to the rear to be sure no one is behind the machine. Watch carefully for traffic when crossing or working near roadways.
11. When moving forward, **do not** suddenly put the tractor in reverse by rapidly pulling on the steering levers, especially when going downhill, as this can lift the tractor tail wheel off the ground and set up a bucking motion due to operator overcontrol. If bucking does occur, immediately stop the bucking action by pulling the Forward Speed Control (FSC) lever into the **NEUTRAL-PARK** position.
12. **The maximum recommended slope operating angle is 15 degrees or 27% grade.** When operating the machine on a slope, reduce speed and use caution to start, stop, and maneuver. To prevent tipping or loss of control of the machine, avoid sharp turns or sudden changes in direction. **Do not operate the machine on a slope greater than 15 degrees.**
13. **Do not touch the engine or muffler while the engine is running** or immediately after stopping the engine. These areas may be hot enough to cause serious burns.
14. When leaving the machine unattended, disengage the PTO clutch, stop the engine, and remove the ignition key.
15. **Do not use flammable materials in the sprayer.**
16. Never allow the water hose used to fill the tank to reach down into the mixed spray solution. The end of the hose could be contaminated.
17. Maintain a steady and slow speed when spraying. Be aware of changing weather conditions. Any blow back on the operator can be harmful. The chemicals can be absorbed via skin and inhalation.
18. Spraying above shoulder height with the spray wand may cause the operator to be covered by blow back of mist leading to skin exposure plus mist inhalation.
19. Always properly dispose of excess material in accordance with your local laws and the chemical manufacturer's guidelines.
20. After each spraying session, always properly clean the sprayer for equipment longevity and to prevent accidents.

## MAINTENANCE

**NOTE:** Refer to your tractor Operator's Manual for safety instructions for tractor maintenance.

1. **To prevent accidental starting of the engine** when servicing or adjusting the machine, remove the key from the ignition switch and disconnect the fuel solenoid wire [diesel engines] or the spark plug wire(s) [gasoline engines].
2. **To reduce fire hazards,** keep the engine free of grass, leaves, excessive grease, and dirt.
3. Keep all nuts, bolts, and screws tight **to ensure the machine is in a safe, working condition.**

4. **Perform only maintenance instructions described in this manual.** Unauthorized maintenance operations or machine modifications may result in unsafe operating conditions.
5. If the engine must be running to perform a maintenance adjustment, **keep hands, feet and clothing away from moving parts. Do not wear jewelry or loose clothing.**
6. Altering the equipment or engine in any manner which adversely affects its operation, performance, durability or use **will VOID the warranty** and may cause hazardous conditions.
7. Never attempt to disconnect any safety devices or defeat the purpose of these safety devices.
8. **Use genuine factory replacement parts.** Substitute parts may result in product malfunction and possible injury to the operator and/or others.

**IMPORTANT:** Keep all applicable manuals immediately accessible to anyone who may operate or service this machine

## SAFETY, CONTROL, AND INSTRUCTION DECALS

Safety, Control, and Instruction Decals are installed on the equipment; if any are missing, illegible, or damaged, a replacement should be ordered and installed before operating the equipment.



**Safety Decal: Chemical Hazards**

**Location: Sprayer Tank**

# Assembly and Installation

## ASSEMBLY

Follow these steps to assemble the spray tank prior to installing it on the tractor. These steps must be used in conjunction with the **A16 Boom Sprayer Parts Diagram on page 16**.

1. Install the left (P/N B029, #30) and right (P/N B030, #38) Tank Supports on the bottom of the tank. Install them with the single hole on the side of the channel facing toward the front and to the outside as shown in the parts diagram. Use four (4) F091 5/16" x 5/8" hex bolts. **DO NOT TIGHTEN ANY HARDWARE UNTIL DIRECTED.**
2. Install the Rear Support Brackets and Support Tubes. The A16 ships with support brackets to mount on most compatible decks. Differences in the carrier frames require additional hardware on a few of the decks (DS52, DS60, and DS62). See the appropriate following section for these decks.

**NOTE:** The DC52R and the DM52A use a different carrier frame than the DS52 and therefore do not require additional mounting hardware.

- If you are installing on a DS52 or DS60, skip to the section, **For DS52 and DS62 on page 8**.
- If you are installing on a DS60, skip to the section, **For DS60 on page 9**.

### For All Compatible Decks (other than the DS52, DS60, and DS62)

Use the two (2) included Rear Support Brackets (P/N B028, #31).

- a. Using two (2) F034 5/16" x 3/4" flange bolts and F009 nuts mount each Rear Support Bracket to the left and right Tank Supports as shown in the parts diagram.
- b. Install the Support Tube (P/N B025, #35) on the left and right Tank Supports in front of the Rear Support Brackets using the two U-bolts (B035, #34) and four (4) F427 5/16"

flange nuts into the appropriate set of holes.

- **For the 42" and 48" carrier frames**, use the **rear** set of holes closest to the Rear Support Brackets.
- **For the 52" carrier frame**, use the **front** set of holes.

The tube should be installed with the holes in the **vertical position**. The tube should be positioned with **2-1/8" extending past** the Tank Supports on each end. **Tighten all hardware installed.**

- c. Invert the unit, slide the left (P/N B027, #33) and right (P/N B034, #37) Support Tube Assemblies into the end of the Support Tube in a fully extended position.
- d. Install the locking pins (P/N B026, #32) into the tubes.
- e. Continue the assembly with Step 3 installing the Boom Supports on **page 9**.

### For DS52 and DS62

The following components must be purchased separately to mount the sprayer on these decks:

- Two (2) x B037 Mounting Bracket, 52/62

The included Rear Support Brackets (P/N B028, #31) are not used with these decks.

- a. Using two (2) F034 5/16" x 3/4" flange bolts and F009 nuts mount each B037 Mounting Bracket to the left and right Tank Supports. (These brackets will be in the same position as the #31 brackets in the parts drawing.)
- b. Install the Support Tube (P/N B025, #35) using the holes immediately in front of the Rear Support Brackets on the left and right Tank Supports with (2) two U-bolts (B035, #34) and four (4) F427 5/16" flange nuts. The tube should be installed with the holes in the **vertical position**. The tube should be positioned with **2-1/8" extending past** the Tank Supports on each end. **Tighten all hardware installed.**

- c. Invert the unit, slide the left (P/N B027, #33) and right (P/N B034, #37) Support Tube Assemblies into the end of the Support Tube. The RH assembly (P/N B034) is fully extended on both the DS52 and DS62. The LH assembly (P/N B027) is installed in the center hole for the DS52 and is fully extended for the DS62.
- d. Install the locking pins (B026) into the tubes.
- e. Continue the assembly with Step 3 installing the Boom Supports on **page 9**.

#### For DS60

Order the following components to mount the sprayer on this deck:

- Two (2) x B028-1 Support Bracket/60, Rear

The included Rear Support Brackets (P/N B028, #31) are not used with this deck.

- a. Using two (2) F034 5/16" x 3/4" flange bolts and F009 nuts mount each B028-1 Support Bracket to the left and right Tank Supports. (These brackets will be in the same position as the #31 brackets in the parts drawing.)
  - b. Install the Support Tube (P/N B025, #35) using the holes immediately in front of the Support Brackets on the left and right Tank Supports with two (2) U-bolts (B035, #34) and four (4) F427 5/16" flange nuts. The tube should be installed with the holes in the **vertical position**. The tube should be positioned with **2-1/8" extending past** the Tank Supports on each end. **Tighten all hardware installed.**
  - c. Invert the unit, slide the left (P/N B027, #33) and right (P/N B034, #37) Support Tube Assemblies into the end of the Support Tube in a fully extended position.
  - d. Install the locking pins (P/N B026, #32) into the tubes.
3. Install the Boom Supports (P/N B031, #36) on the front of the left and right Tank Supports using a F093 5/16-18 x 1 hex bolt and a F020 nut.
  4. Center the Main Boom (P/N B032, #39) on the supports and place a Boom Extension (P/N

B033, #26) above the Main Boom on each end. The end hole of each extension should line up with the Main Boom's second hole from each end as shown in the parts diagram. Secure each side with a F093 5/16-18 x 1 hex bolt and F427 5/16-18 flange nut. Tighten these bolts so the extensions can be moved by hand.

5. Install a F433 5/16-18 x 1/2 carriage bolt and a F020 nut on each Boom Extension (P/N B033, #26) in the second hole from the middle with the head of the carriage bolt facing down so it engages the large hole in the end of the Main Boom when extended as shown in the parts diagram.
  6. Install the three (3) Wind Screen Supports (P/N B036-2, #28) using a F646 3/8-16 x 3/4 serrated hex bolt, a F170 washer, and a F570 flange top lock nut. Install the S-hooks (P/N B036-3) for mounting the windscreen and squeeze them to secure.
- NOTE:** Keep the S-hooks loose enough that the screen can be easily removed. The screen should not be stored on the boom to protect it from damage.
7. Install the hose assembly into the holes on the Wind Screen Supports. The Tip Strainer (P/N B015, #27) is inline with the Spray Tip (P/N B014-1, #25), and the assembly is secured to the Wind Screen Support with the Cap Nut (P/N B016, #29) as shown in the parts diagram. The spray tip must be positioned with the slot parallel to the spray boom.



**Install Hose Assembly**

**INSTALLATION**

When installing the sprayer on your Walker tractor, select a smooth, flat surface such as a driveway, sidewalk, garage floor, etc. to mount the sprayer to the deck's carrier frame.

1. **Initial Installation Only:** Install the Harness/Battery Connector (P/N B005) to the tractor's battery. The red wire connects to the positive terminal and the black wire to the negative.
2. Install the sprayer on the deck. Leave one locking pin in either the RH or LH Support Tube Assembly. Hook the Rear Support Bracket of the boom sprayer under the front of the deck carrier frame. Slide the unlocked Support Tube Assembly out to the deck carrier frame arm and lock with the locking pin as shown in the **Install Boom Sprayer on Deck** photo. If pin is tight, gently tap into place with a hammer.

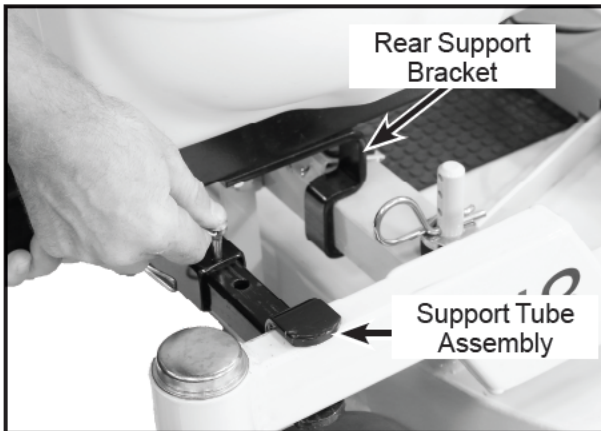

**Install Boom Sprayer on Deck**

3. Connect the Wire Harness (P/N B004) to the Pump (P/N B003).
4. **Initial Installation Only:** Route the Wire Harness where it won't be cut or pinched by a moving part. It is recommended to secure the harness with zip ties at several locations to protect it.

**For the DS60:** Install the 30" Wire Harness Ext (P/N B005-1, sold separately) in line with the Wire Harness as an extension to reach the Harness/Battery Connector.

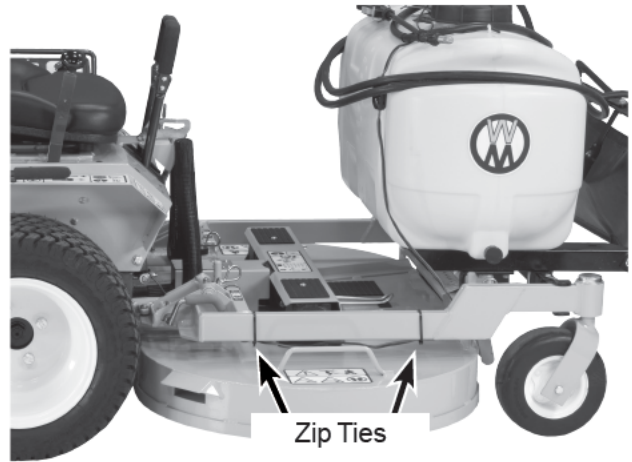

**Route and Secure Wire Harness**

5. Connect the Wire Harness to the Harness/Battery Connector.

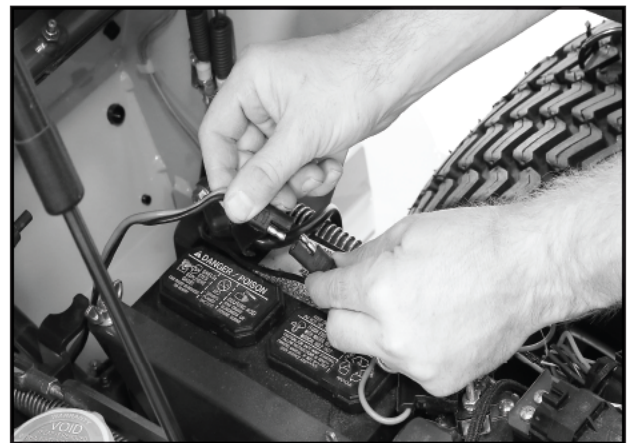

**Connect Wire Harness**

6. Test the sprayer by putting about 5 gallons of water in the tank. Operate the unit and check the boom's spray pattern for coverage and overlap of spray.

**NOTE:** Release the air pressure in the spray wand to initiate the check valves in the spray boom by opening the spray wand valve (P/N B017) until spray material flows from the wand.

The base of the spray tips should be about 17" from the ground for a good spray pattern. Also check to see that the spray tips are installed correctly so the spray pattern is parallel to the spray boom.

## Operating

### CHEMICAL SAFETY

Always adhere to the following guidelines when working with the sprayer.

- **Do not** use any flammable materials in this sprayer.
- Follow the spray material manufacturer's directions for each spray material.
- Never allow the water hose used to fill the tank to reach down into the mixed spray solution. The end of the spray hose could be contaminated.
- Always follow the spray manufacture's directions to properly neutralize the chemicals during the post-use cleaning of the sprayer.
- A material safety data sheet (MSDS) provides specific details on any spray material being used and should be available on request from each chemical manufacturer or distributor.

### PUMP OPERATING PRESSURES

The SHURflo pump pressure switch is factory preset to turn the pump on and off at 100 PSI.

The spray wand has a flow rate of 1 gallon (3.78 L) per minute. At this flow rate, the pump operating pressure will be about 60-65 PSI. This operating pressure gives optimal, continuous spray wand performance.

The spray boom has three (3) 11008 EVS spray tips that have a total flow rate of 2.4 gallons (9 L) per minute. At this flow rate, the pump operating pressure will be about 30 PSI due to reduced flow restriction. This will result in less drift and better spray coverage of plants.

### CALIBRATING THE APPLICATION RATE

The flow rates and operating pressures for this pump result in actual spraying times of:

- 42 minutes with the spray wand
- 20 minutes with the spray boom

When spraying with the spray boom, plan on **driving about 2.5 MPH, or 220 feet per minute (4 km/h, or 67 meters per minute)**. That results in 33,000 square ft. of application per tank. With approximately 10% overlap, **place enough chemical material in the tank to cover 30,000 square ft. (2800 square meters) of area.**

## OPERATING THE SPRAYER

### CAUTION

Always wear adequate protective clothing including long pants, substantial protective footwear, gloves, and eye protection when mixing chemicals or spraying. Wear a mask or face shield if necessary.

1. Calculate the amount of chemical needed to complete the job using the application rate, and only mix what is needed.
2. Fill the sprayer where spills cannot harm the vegetation.

**NOTE:** If you are using a wettable powder be sure to mix the material well before spraying. This can be done by using the spray wand to stir the material for a period of time to make sure it is thoroughly mixed.

3. Visually inspect the hoses and nozzles on the sprayer for leaks or damage before spraying.
4. Check spray tip height and spray pattern on the spray boom. Tips should be about 17" from the ground to the base of the tip. Spray tips should be aligned so the spray pattern is perpendicular to the direction of travel.
5. Release the air pressure in the spray wand to initiate the check valves in the spray boom by opening the spray wand valve (P/N B017) until spray material flows from the wand.

**NOTE:** Never let the sprayer operate in one spot, always turn the pump off when the tractor is stopped.

6. Use the toggle switch to turn on the spray boom when actively moving and ready to spray.

**NOTE:** Turn the sprayer off during turns to avoid double spraying.

### CAUTION

Maintain a steady and slow speed around 2.5 MPH (4 km/h) when spraying. Be aware of changing weather conditions. Any blow back on the operator can be harmful. The chemicals can be absorbed via skin and inhalation.

## INSTALLING THE WIND SCREEN

Depending on the wind condition you may, or may not, want to install the Wind Screen to prevent spray drift. Remove the Wind Screen when the sprayer is not in use to protect it from damage. To install the screen, hook the rings over the S-hooks mounted on the Wind Screen Support Brackets.

## CLEANING THE SPRAYER

After every spray session, it is recommended to follow these steps to clean the sprayer.

1. Dilute the remaining chemical and spray this mixture on the area just treated until it is gone.
2. Clean the sprayer and rinse with clean water.

**NOTE:** Always follow the spray manufacture's directions to properly neutralize the chemicals if necessary.

3. Operate the spray nozzles until all water is gone.

## Maintenance

### CLEANING THE STRAINERS

Clean the strainers if you notice impeded performance or before storage.

#### Spray Boom Tip Strainers

1. For each spray nozzle, remove the Cap Nut, the Spray Tip, and the Tip Strainer from the hose assembly.
2. Wash Tip Strainer and Spray Tip under a faucet.
3. Reassemble and install.



Tip Strainer

#### Sump Strainer

1. Remove Tank Cap.
2. Lift the suction hose and unscrew the Sump Strainer.
3. Wash the Sump Strainer under a faucet and reinstall.



Sump Strainer

#### Spray Wand Tip

1. Unscrew the Spray Wand Tip from the spray wand.
2. Wash the tip under a faucet and reinstall.



Spray Wand Tip

### STORAGE OF THE SPRAYER

Follow this procedure before storing the sprayer for an extended period of time.

1. Remove and store the Wind Screen.
2. Clean the sprayer and rinse with clean water.
3. Operate the unit until all water is out of the system.
4. Follow the steps on **Cleaning the Strainers on page 13**.
5. Disconnect the Wire Harness from the pump. The harness can be left on the deck and tucked out of the way, or it can be removed if a different deck or implement will be installed.
6. Store the unit dry. It is best to protect the sprayer from freezing weather if possible.



## Troubleshooting

If you encounter issues with the sprayer not working optimally, this section provides a few common things to check. If these do not correct the issue, contact your local authorized Walker Dealer.

### PUMP LOSES SUCTION

1. Clean the Sump Strainer as detailed on page 13.
2. Check for loose or cracked fittings on the suction side of the pump.

### PUMP CAPACITY DECREASED

1. Clean spray boom's Tip Strainers and Spray Tips as detailed on page 13.
2. Check that the In-Line Valve (P/N B022, #8) to boom isn't partially closed.
3. Verify that the hose isn't kinked restricting flow.

### POOR SPRAY PATTERN

1. Adjust the Spray Tip height.
2. Adjust the Spray Tip direction.
3. Check the Tip Strainers.

### PUMP VIBRATES OR SWITCHES ON AND OFF

Adjust the Allen screw in the top of the pump. Turn the screw **clockwise** to increase the pump pressure and alleviate the pump turning on and off. This condition will exist when the spray wand is being used in the fine mist spray pattern where flow is restricted. The condition of the pump turning on and off will not hurt the pump.

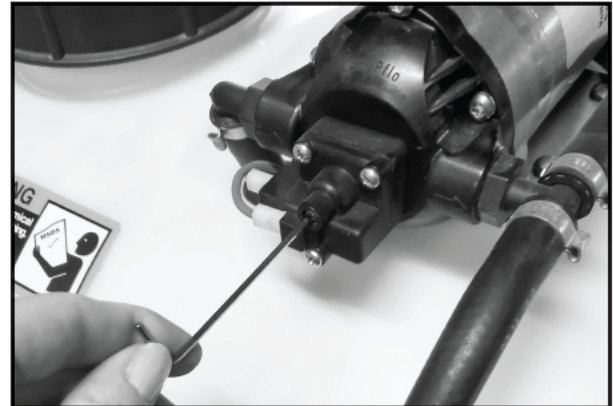

Adjust the Pump Pressure

### PUMP DOES NOT RUN

1. Check the condition of battery.
2. Check the Wire Harness condition and connections. Inspect the switch.
3. Check the fuse in the Harness Battery Connector.
4. Be sure either the spray wand or the spray boom valve is open allowing the pump to operate.

# Parts Lists and Diagrams

## A16 BOOM SPRAYER PARTS LIST

ITEM NO.	PART NO.	DESCRIPTION	NO. REQ'D	ITEM NO.	PART NO.	DESCRIPTION	NO. REQ'D
<b>Pump, Hose and Wand Components</b>				<b>Fasteners</b>			
1	B017	Spray Wand W/Tip (#43238)	1	F009		5/16-18 Whiz Locknut	4
2	B010	Hose Clamp (3/8)	5	F020		5/16-18 ESNA Nut	4
3	B020	Sump Strainer (#43258)	1	F025		10-24 x 3/8 PPHMS	2
4	B021	Poly Straight Fitting (3/8) (#43182)	1	F034		5/16-18 x 3/4 Hex Bolt	4
5	B007	Elbow, Poly 3/8 (#43183)	1	F091		5/16-18 x 5/8 Hex Bolt	4
6	B003	Pump (#43178)	1	F093		5/16-18 x 1 Hex Bolt	4
7	B008	Poly Tee (3/8) (#43235)	1	F170		5/16 x 1 x 7/64 Flat Washer (Zinc Plate)	3
8	B022	In-Line Valve (#43014)	1	F306		3/8-16 x 3/4 Hex Bolt	2
9	B011	Poly Tee Hose, 3/8 (43013)	1	F396		10-24 x 1-1/4 PPH Bolt	4
10	B012	End Tip Fitting W/Nut (#43011)	2	F427		5/16-18 Flange Nut	6
11	B013	Tee Tip Fitting W/Nut (#43192)	1	F433		5/16-18 x 1/2 Carriage Bolt	2
12	B009	Hose (3/8 x 20/Black)	1	F570		3/8-16 Flange Top Lock Nut	3
				F646		3/8-16 x 3/4 Serrated Hex Bolt	3
<b>Tank Components</b>				<b>Service Parts (Not Shown)</b>			
13	B002	Cap, Tank (#43175)	1	B017-1		Spray Wand Tip	
14	B002-1	Rubber Gasket (#ST43882)	1	B003-1		Pump Head	
15	B019	Hose Clip (#43191)	1				
16	B018	Spray Wand Holder (#43130)	1				
17	B001-1	Tank, 25 Gallon	1				
18	5800-9	Decal, Walker Round (4-3/4")	2				
19	B022-1	Decal, Caution (#43239)	1				
20	B002-2	Cap, Drain W/Washer	1				
<b>Electrical Components</b>							
21	B004	Wire Harness (#43472)	1				
22	B005	Harness/Batt Conn(ST43483)	1				
<b>Frame Mount</b>							
23	B036-3	S-Hook, Wind Screen	3				
24	B036-1	Wind Screen	1				
25	B014-1	Spray Tip	3				
26	B033	Boom Extensions (#43170)	2				
27	B015	Tip Strainer/Check Valve (#43016)	3				
28	B036-2	Support, Wind Screen	3				
29	B016	Cap Nut, Tip Fitting (#43012)	3				
30	B029	Tank Support, LH (#43320)	1				
31	B028	Support Bracket, Rear (#43319)	2				
32	B026	Locking Pins (#43317)	2				
33	B027	Support Tube Assy, LH (#43318)	1				
34	B035	U-Bolt (#43323)	2				
35	B025	Support Tube (#43316)	1				
36	B031	Boom Supports (#43168)	2				
37	B034	Support Tube Assy, RH (#43322)	1				
38	B030	Tank Support, RH (#43321)	1				
39	B032	Main Boom (#43169)	1				

# A16 BOOM SPRAYER PARTS DIAGRAM

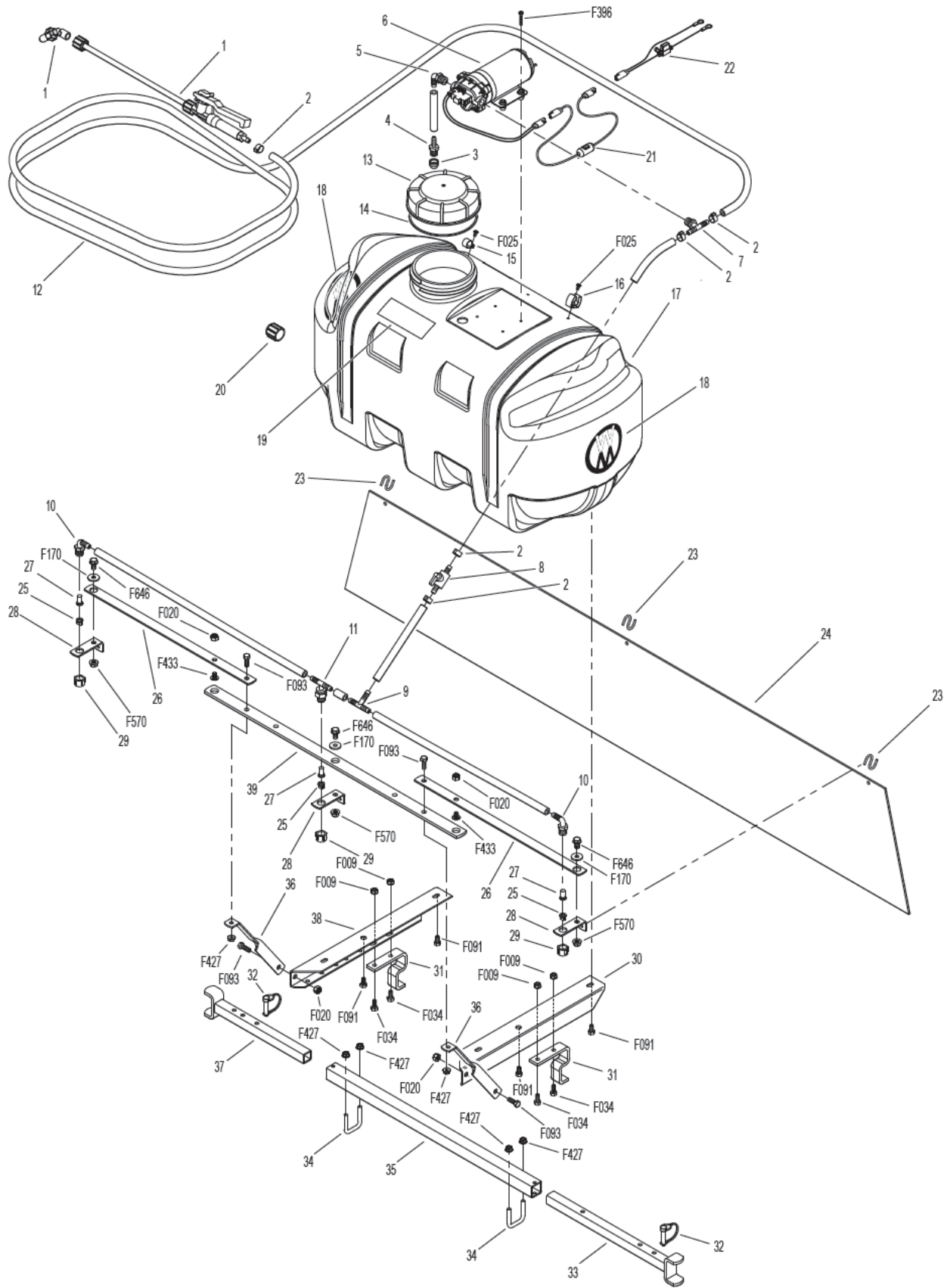

Use only genuine Walker® parts.







## LIMITED WARRANTY FOR WALKER A16 BOOM SPRAYER

### 1. What this warranty covers, and for how long:

Walker Manufacturing company will, at its option, repair or replace, without charge, any part covered by this warranty which is found to be defective in material and/or workmanship within one (1) year after date of sale to the original retail purchaser unless the product is used for rental purposes, in which case this warranty is limited to ninety (90) days. At Walker's request, customer will make the defective part available for inspection by Walker and/or return the defective part to Walker, transportation charges prepaid. All parts and components of the Walker A16 Boom Sprayer are covered by this warranty.

### 2. What this warranty does not cover:

- A. This warranty does not cover defects caused by depreciation or damage caused by normal wear, accidents, improper maintenance, improper use or abuse of the product, alterations, or failure to follow the instructions contained in the Operator's Manual for operation and maintenance.
- B. The customer shall pay any charges for making service calls and/or for transporting the attachment to and from the place where the inspection and/or warranty work is performed.

### 3. How to obtain service under this warranty:

Warranty service can be arranged by contacting the dealer where you purchased the machine or by contacting Walker Manufacturing Company, 5925 East Harmony Road, Ft. Collins, CO 80528. Proof of the date of purchase may be required to verify warranty coverage.

### 4. Warranty limitation:

- A. **HERE IS NO OTHER EXPRESS WARRANTY. ANY WARRANTY THAT MAY BE IMPLIED FROM THIS PURCHASE INCLUDING MERCHANTABILITY AND FITNESS FOR A PARTICULAR PURPOSE IS HEREBY LIMITED TO THE DURATION OF THIS WARRANTY AND TO THE EXTENT PERMITTED BY LAW ANY AND ALL IMPLIED WARRANTIES ARE EXCLUDED.** Some states do not allow limitations on how long an implied warranty lasts, so the above limitations may not apply to you.
- B. **WALKER WILL NOT BE LIABLE FOR ANY INCIDENTAL, CONSEQUENTIAL, OR SPECIAL DAMAGES AND/OR EXPENSES IN CONNECTION WITH THE PURCHASE OR USE OF THE MACHINE.** Some states do not allow the exclusion or limitation of incidental or consequential damages, so the above limitation(s) or exclusion(s) may not apply to you.
- C. Only the warranty expressed in this limited warranty shall apply and no dealer, distributor, or individual is authorized to amend, modify, or extend this warranty in any way. Accordingly, additional statements such as dealer advertising or presentations, whether oral or written, do not constitute warranties by Walker, and should not be relied upon.
- D. This warranty gives you specific legal rights, and you may also have other rights which vary from state to state.



**WALKER**

**WALKER MFG. CO. • 5925 E. HARMONY ROAD, FORT COLLINS, CO 80528 • (970) 221-5614**  
**FORM NO. 122220      PRINTED IN USA      [www.walker.com](http://www.walker.com)      ©2020 WALKER MFG. CO**