

# ASSEMBLY INSTRUCTIONS

(SEE ILLUSTRATION BELOW)

1. Assemble a plastic bearing (7) into a hitch tube (2) so that the bearing flange is against the outside of the hitch tube. *You may need to place a block of wood against bearing and carefully tap with a hammer.*
2. Place a cotter pin (12) into the inside hole of the axle.
3. Slide the washer (6), spacer (3), hitch tube (2), washer (6) onto the axle.
4. Place cotter pin (12) into the outside hole of the axle.
5. Repeat steps 1 through 4 on the other side.
6. Bring the two hitch tubes together using three 5/16 X 3" hex bolts (8) and 5/16" nuts (10). **Do not tighten yet.**
7. Assemble hitch brackets (1) to hitch tubes (2) using two 5/16 X 2-1/4" hex bolts (4) and 5/16" nylock nuts (10). **Do not tighten yet.**
8. **Tighten** all bolts and nuts starting with hitch tubes (2), ending with hitch brackets (1).
9. Install hitch pin (9) through hitch brackets (1) and secure with hair cotter pin (5).
10. Adjust plug (11) size by twisting handle. Lock a plug in each end of roller drum by flipping handle down.

# PLUG ADJUSTMENT

(SEE FIGURE 1)

1. Pull plug firmly in opposing directions
2. Twist ring counter-clockwise to tighten

**NOTE:** If the outer washer is not functioning properly, use a pair of needlenose pliers to ensure that it is free.

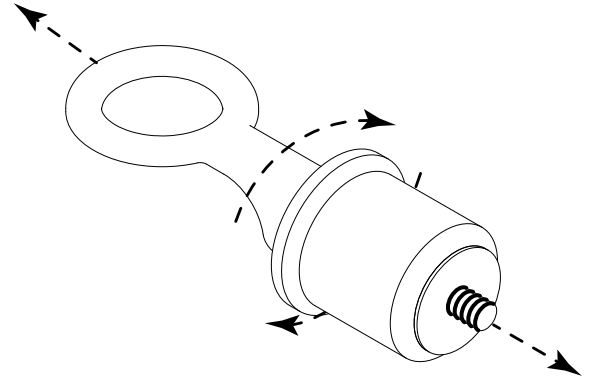

Figure 1.

**CAUTION**

ROLLER WILL CHANGE HANDLING AND BRAKING OF VEHICLE, ESPECIALLY ON SLOPES. FOLLOW TOWING GUIDELINES IN ROLLER AND TOWING VEHICLES OWNER'S MANUALS.  
DO NOT EXCEED SLOPES GREATER THAN 10°

**MAX WEIGHT WITH WATER**

45-0179 — 640 lbs.	45-0268 — 375 lbs.
45-0216 — 910 lbs.	45-0269 — 550 lbs.
45-0267 — 250 lbs.	45-0549 — 1150 lbs.

45906

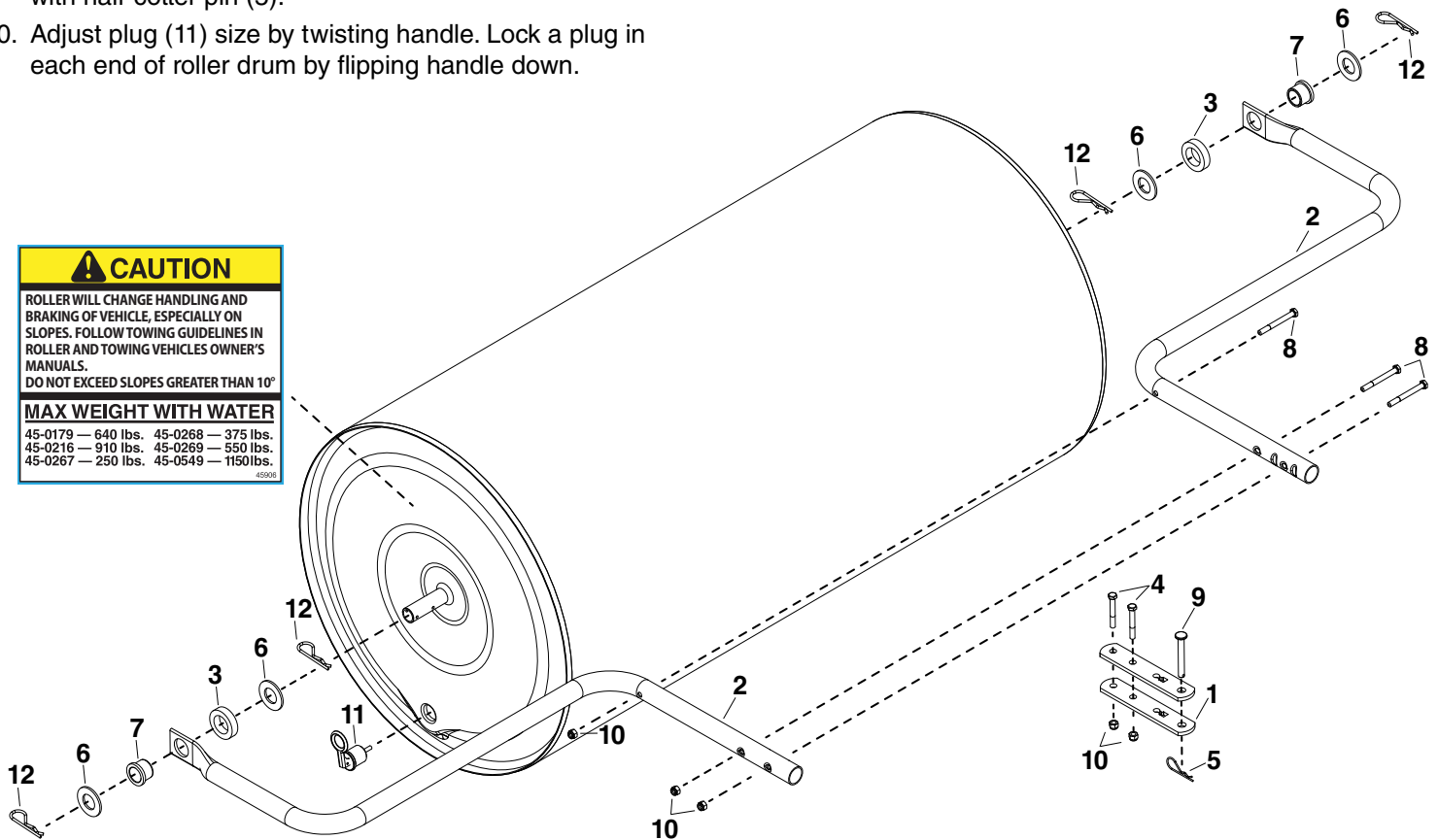

REF	PART NO.	QTY	DESCRIPTION	REF	PART NO.	QTY	DESCRIPTION
1	24192BL1	2	Bracket, Hitch (Straight)	9	47623	1	Pin, Hitch 3/8 x 3"
2	2-257BL3	2	Tube, Hitch (Roller)	10	47810	5	Nut, 5/16-18 Nylock
3	40740	2	Spacer, 1.28 ID x 2.0	11	49467	2	Plug, Roller (1-1/4)
4	43224	2	Bolt, Hex 5/16-18 x 2-1/4"	12	714-0117	4	Pin, Hair Cotter 5/32
5	43343	1	Pin, Hair Cotter			1	Assembly, 24x48 Roller
6	43528	4	Washer, 1" SAE 1.06		3-125	1	Owner's Manual
7	43632	2	Bearing, Plastic		45906	1	Roller Caution Label
8	46782	3	Bolt, Hex 5/16-18 x 3"				